

Pb Free Plating Product

MUR4060PT



40Ampere,600Volt Planar Polyimide Passivated Ultra Fast Recovery Rectifier

APPLICATION

- Freewheeling, Snubber, Clamp
- Inversion Welder
- PFC
- Plating Power Supply
- Ultrasonic Cleaner and Welder
- Converter & Chopper
- UPS

PRODUCT FEATURE

- Ultrafast Recovery Time
- Soft Recovery Characteristics
- Low Recovery Loss
- Low Forward Voltage
- High Surge Current Capability
- Low Leakage Current

TO-3PB(TO-3PN)

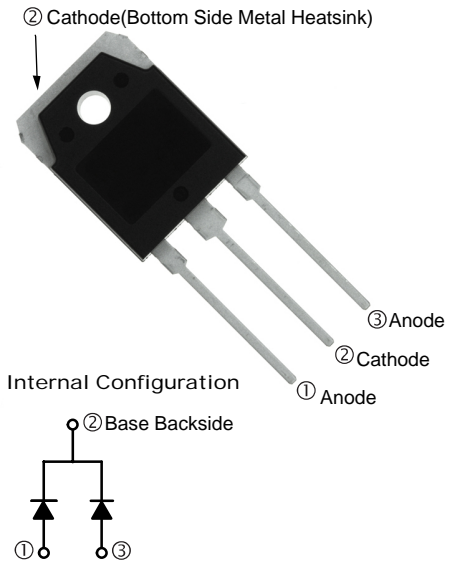

GENERAL DESCRIPTION

MUR4060PT using latest FRED wafer FAB process(or planar passivated pellet) with ultrafast and soft recovery characteristics.

Absolute Maximum Ratings (per diode) $T_C=25^\circ\text{C}$ unless otherwise noted

Symbol	Parameter	Value	Units
V_{RRM}	Peak Repetitive Reverse Voltage	600	V
$I_{F(AV)}$	Average Rectified Forward Current @ $T_C = 100^\circ\text{C}$	40	A
I_{FSM}	Non-repetitive Peak Surge Current 60Hz Single Half-Sine Wave	240	A
T_J, T_{STG}	Operating Junction and Storage Temperature	- 65 to +150	$^\circ\text{C}$

Thermal Characteristics

Symbol	Parameter	Value	Units
$R_{\theta JC}$	Maximum Thermal Resistance, Junction to Case	0.7	$^\circ\text{C/W}$

Electrical Characteristics (per diode) $T_C=25^\circ\text{C}$ unless otherwise noted

Symbol	Parameter	Min.	Typ.	Max	Units	
V_{FM}^*	Maximum Instantaneous Forward Voltage $I_F = 40\text{A}$ $I_F = 40\text{A}$	$T_C = 25^\circ\text{C}$	-	-	2.1	V
		$T_C = 100^\circ\text{C}$	-	-	1.9	
I_{RM}^*	Maximum Instantaneous Reverse Current @ rated V_R	$T_C = 25^\circ\text{C}$	-	-	20	μA
		$T_C = 100^\circ\text{C}$	-	-	200	
t_{rr}	Maximum Reverse Recovery Time	-	-	110	ns	
I_{rr}	Maximum Reverse Recovery Current	-	-	10	A	
Q_{rr}	Maximum Reverse Recovery Charge ($I_F = 40\text{A}, di/dt = 200\text{A}/\mu\text{s}$)	-	-	550	nC	
W_{AVL}	Avalanche Energy	1.0	-	-	mJ	

* Pulse Test: Pulse Width=300 μs , Duty Cycle=2%

Typical Characteristics

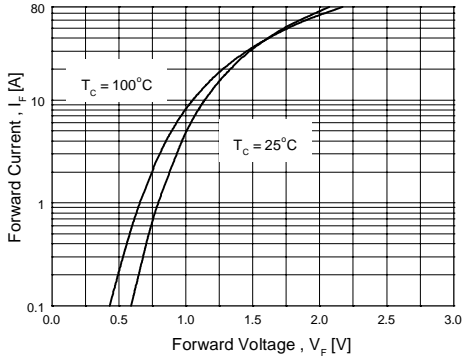

Figure 1. Typical Forward Voltage Drop vs. Forward Current

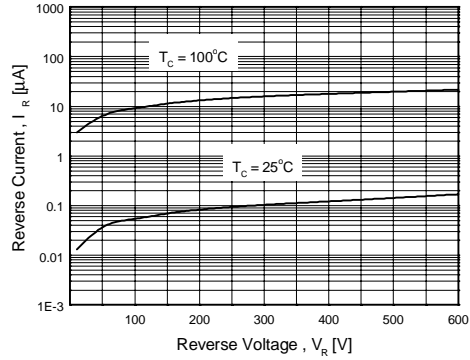

Figure 2. Typical Reverse Current vs. Reverse Voltage

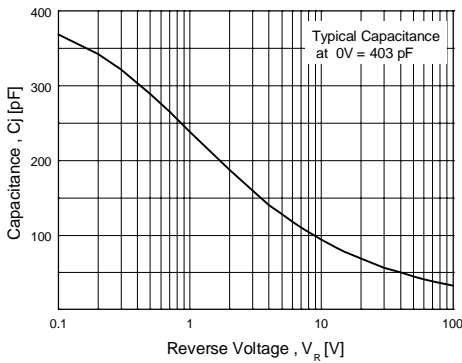

Figure 3. Typical Junction Capacitance

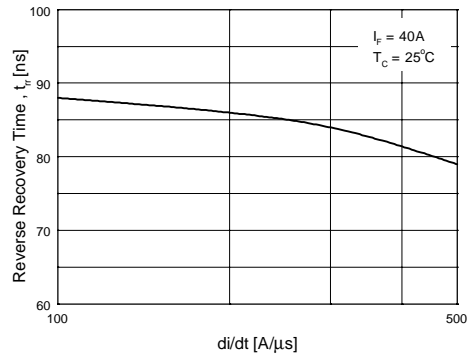

Figure 4. Typical Reverse Recovery Time vs. di/dt

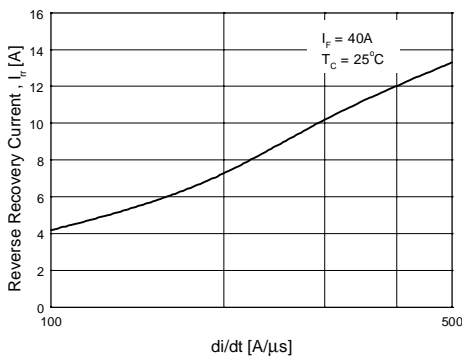

Figure 5. Typical Reverse Recovery Current vs. di/dt

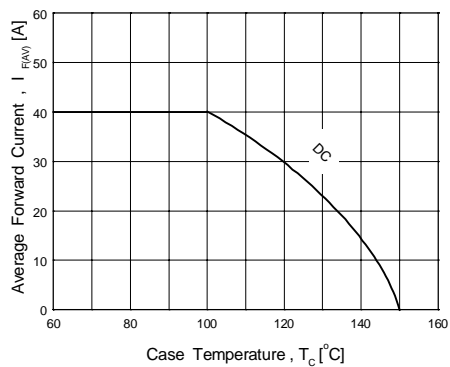

Figure 6. Forward Current Derating Curve

